



# **PB-600**

## **Instruction Manual**



## PB-600 Instruction Manual

### Index

---

0.Product description.....	1
1.Notes on operation .....	1
2.Front and back panel .....	1
3.Derating curve.....	2
3.1 Charging current VS temperature.....	2
3.2 Charging current VS input voltage.....	2
4.Function description for CN100.....	2
5.LED Indication.....	3
6.Explanation of operation logic (charging stages).....	3
6.1 2 stage charging (flick switch to "2" stage).....	3
6.2 3 stage charging (flick switch to "3" stage).....	4
6.3 8 stage charging (flick switch to "8" stage).....	5
7.Function description .....	6
7.1 Input voltage .....	6
7.2 PFC .....	6
7.3 Remote control.....	6
7.4 2, 3, or 8 stage charging mode selection .....	7
7.5 Reverse polarity protection .....	7
7.6 Fan speed control.....	7
7.7 Charger OK relay (RY15).....	7
7.8 Output OK relay (RY13).....	8
7.9 Temperature compensation .....	8
8.Wiring for battery.....	8
9.Suggested battery capacity.....	9
10.Series and parallel connection of batteries .....	9
11.Recommended wire specification .....	9
12.Failure correction notes .....	10

---

## 0. Product description

PB-600 is MW's next generation smart charger. It has many of the protective features that consumers would like to have in a charger including battery misconnection (wrong voltage), reverse polarity, battery disconnection or not connected, and battery failure analysis. The latest high efficiency switching topology plus microcontroller power management are utilized in its design. Three types of charging curves are offered for lead acid battery charging, 2 stages for quick charging, 3 stages (quick + float), and 8 stages for optimized charging. Charging stage selection can be easily made by the user through the selection switch on the front panel.

Depending on battery brand and type (lead acid, gel, lithium iron, and lithium manganese); the battery may require special charging curves and adjustment to the protective functions which differs from the standard settings. The charging curves and protective functions can be customized by reprogramming its firmware. Basically, you can change the voltage/current settings of each individual stage plus adjust or cancel the protective functions. Please note, the factory charging curve is for charging lead-acid battery. Please contact MW regarding other types of battery charging requirements.

## 1. Notes on operation:

- ⦿ Designed for charging lead acid battery.
- ⦿ Must be installed in a dry and well ventilated area. It should not be exposed to rain or snow.
- ⦿ The cables between charger and battery should be kept as short as possible to prevent excessive voltage drop. Too much voltage drop will lead to longer charging period.
- ⦿ Please make sure charging voltage and current meets battery specification.
- ⦿ Refrain from connecting new and old batteries in series.
- ⦿ Charger should be in the OFF mode before making battery connection or disconnection.
- ⦿ Three years warranty is provided under normal operating conditions. Failure resulting from improper operation will result in cancellation of warranty.

## 2. Front and back panel

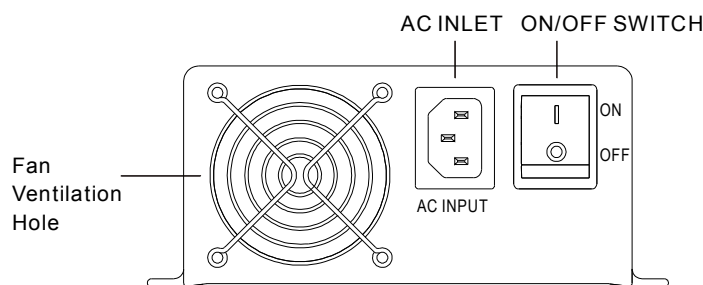

Figure 2.1 Front Panel

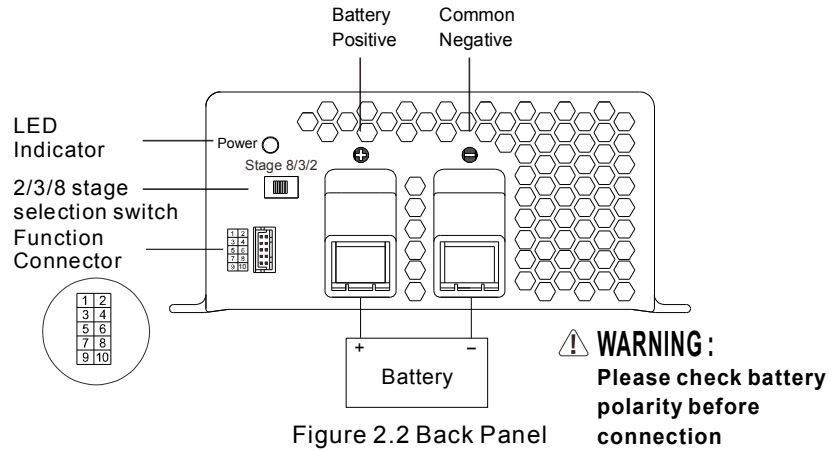

Figure 2.2 Back Panel

**Assembly guidelines:**

1. The charger should be turned OFF prior to battery connection. Suitable wire gauge should be chosen based on rated charging current of the charger unit. Double-check battery polarity before making the battery connection. Positive terminal of the charger must be connected to + of the battery and negative terminal to of the battery. Also, make sure the positive and negative terminals of the charger are not accidentally shorted together.
2. After plugging in the AC power cable, flick the ON/OFF (0/-) switch to the ON(-) position. The LED indicator on the switch will light up.

**3. Derating curve**

**3.1 Charging current VS temperature**

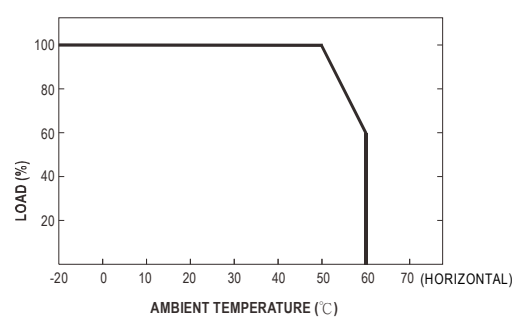

**3.2 Charging current VS input voltage**

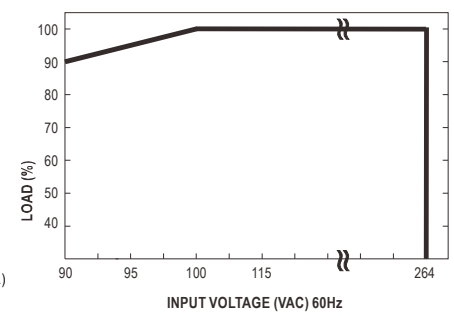

**4. Function description for CN100**

Pin No.	Function	Description
1,2	RY13	Relay contact rating (max.): 30V/1A. "Short" when battery is full. "Open" when battery is still charging.

Pin No.	Function	Description
5,6	RY15	Relay contact rating (max.): 30V/1A. "Short" when the unit is working normally; "Open" when the unit is in a faulty condition
7,8	GND/RTH	Temperature sensor which comes with the charger can be connected to the unit to allow temperature compensation of the charging voltage. <b>If the temperature sensor is not used, the charger can still work normally.</b>
9,10	RC-/RC+	Turn the output ON and OFF by electrical or dry contact between pin10 (RC+) and pin9 (RC-). Open: start charging. Short: stop charging.

### 5.LED Indication

Status	Steady	Flashing
Color		
Red	Fail	
Orange		Charging
Green	Full	Charging

Types of failure: ① Battery disconnected ② Damaged battery ③ Reverse polarity  
 ④ Incorrect battery voltage (e.g. PB-600-12 connected to 24V battery)  
 ⑤ Activation of protection function (e.g. OTP, OVP, and Short)

### 6.Explanation of operation logic (charging stages):

PB-600 has a total of 3 charging modes to choose from, 2 stages, 3 stages, and 8 stages. 8 stages charging differ from 2 stages with the addition of pulse, soft start, analysis, recondition, float, and maintain stages. 2 stages provide simple and quick charging. 3 stages is similar to 2 stages with the exception of not shutting OFF after the battery is fully charged. Lastly, 8 stages will allow charging to maximum capacity. User can select between 2,3 or 8 stages depending on their requirement.

#### 6.1 2 stage charging (flick switch to "2" stage)

During initial charge (stage 1), charger will provide maximum current to the battery. The built-in fan will also turn ON. As the battery starts to get full, charging current will gradually decrease (stage 2). When charging current decrease to less than 10% of max. LED indicator will turn Green to show a full charge and the charger will turn OFF.

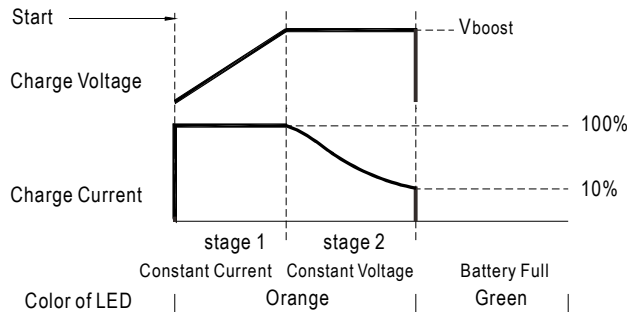

State	PB-600-12	PB-600-24	PB-600-48
Constant Current	40A	21A	10.5A
Vboost	14.4V	28.8V	57.6V

Figure 6.1 2 stage charging curve

**Explanation for 2 stages charging curve**

(0)Initial stage (battery analysis):

Check battery voltage level to see if it is within the normal range, whether or not a battery is connected, or if the battery is already full and further charging is not required.

(1)Stage 1 (constant current):

A constant current is provided so the battery can be quickly charged to 2.4V per cell.

(2)Stage 2 (constant voltage):

A constant voltage of 2.4V per cell is provided until the charging current naturally tapers down to 10% then stop charging.

**6.2 3 stage charging (flick switch to "3" stage)**

During initial charge (stage 1), charger will provide maximum current to the battery. The built-in fan will also turn ON. As the battery starts to get full, charging current will gradually decrease (stage 2: programmed to last no longer than 24hrs). When charging current decrease to less than 10% of max. LED indicator will turn Green to show a full charge. The charger will now maintain a float charge voltage (stage 3).

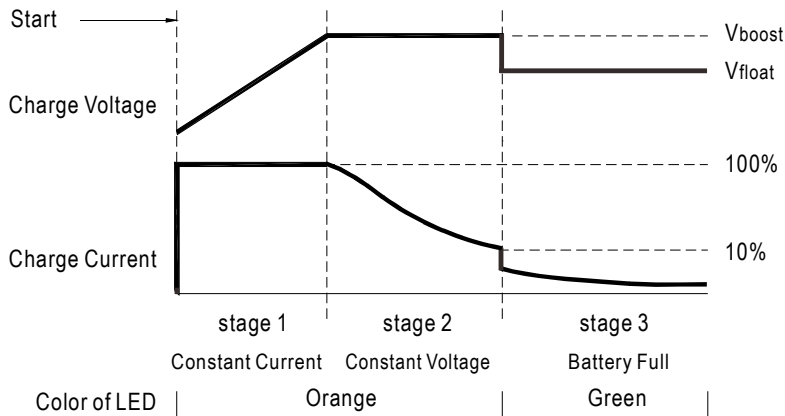

State	PB-600-12	PB-600-24	PB-600-48
Constant Current	40A	21A	10.5A
Vboost	14.4V	28.8V	57.6V
Vfloat	13.8V	27.6V	55.2V

Figure 6.2 3 stage charging curve

**Explanation for 3 stages charging curve**

(0)Initial stage (battery analysis):

Check battery voltage level to see if it is within the normal range, whether or not a battery is connected, or if the battery is already full and further charging is not required.

(1)Stage 1 (constant current):

A constant current is provided so the battery can be quickly charged to 2.4V per cell.

(2)Stage 2 (constant voltage):

A constant voltage of 2.4V per cell is provided until the charging current naturally tapers down to 10% then move on to stage 3.

(3)Stage 3 (Float voltage):

A float voltage of 2.3V per cell is provided so that the battery can maintain full charge.

\*For applications that utilize the charger (PB-600) to charge batteries and supply system power simultaneously(e.g. UPS system), please select "3 stage" charging for the best use of the charger.

**6.3 8 stage charging (flick switch to "8" stage)**

8 stage charging provides optimized charge to lead acid battery. It also prolongs battery life and increase storage capacity. Some of the main advantages are as below:

- ⊙ Advantage of pulse stage: Use pulse current to revive aged battery.
- ⊙ Advantage of recondition stage: Allow full charge of battery.
- ⊙ Advantage of float and maintain stage: After LED turns green, maintenance charge is provided so the battery is always in a full state. User will have access to a full battery whenever it is disconnected from the charger.

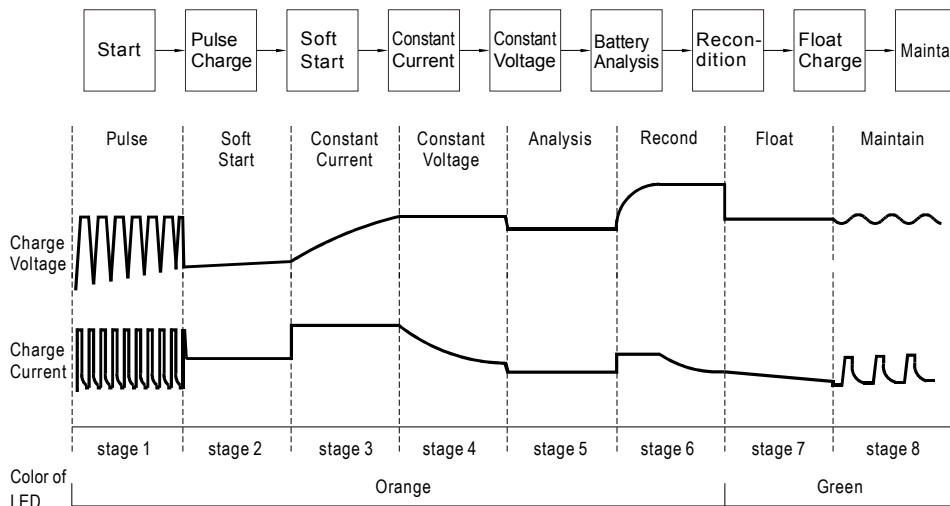

Figure 6.3 8 stage charging curve

### **Explanation for 8 stages charging curve**

(0)Initial stage (battery analysis):

Check battery voltage level to see if it is within the normal range, whether or not a battery is connected, or if the battery is already full and further charging is not required.

(1)Stage 1 (pulse charging):

Pulse charging is used to revive tired lead acid battery which is either improperly charged/discharged or allowed to self-discharge as occurs during non-use. Basically, help to restore its normal chemical properties.

(2)Stage 2 (soft start):

Use low charge voltage and current to prepare the battery to accept upcoming bulk charging, so a better charge can be applied.

(3)Stage 3 (constant current):

A high constant current is provided so the battery can be quickly charged to 2.4V per cell.

(4)Stage 4 (constant voltage):

A constant voltage of 2.4V per cell is provided until the charging current naturally tapers down to a low level.

(5)Stage 5 (analysis):

The charger will stop charging for 2 minutes to determine battery status. If the battery voltage is higher than 2.1V per cell, the battery is determined as OK and will move on to stage 6. If the battery voltage is lower than 2.1V per cell, the battery fail indication will come ON and the charger will stop charging.

(6)Stage 6 (recondition boost charge):

Boost voltage is provided to recondition the battery storage capacity to its original state.

(7)Stage 7 (float charge):

A float voltage of 2.3V per cell is provided for extended period of time(about one day) so that the battery can maintain full charge.

(8)Stage 8 (maintain):

Maintenance charge is provided to compensate for battery self-discharge and extend battery life.

## **7.Function description**

### **7.1 Input voltage**

- ⊙Input voltage range is 90~264Vac or 127~370Vdc.
- ⊙The provided input voltage must fall within the specified range otherwise the unit may be non-functional also the active PFC circuit may fail or get damaged.
- ⊙Efficiency will get lower when input voltage is at low line. Please note, load derating will be required when input voltage is below 100Vac.



### 7.2 PFC

◎ Built-in active PFC circuit: PF > 0.95 when input voltage is between 90~230Vac with full load at the output. On the other hand, if the input voltage is > 230V or output is not at full load, the PF will drop below 0.95.

### 7.3 Remote control

The charger can be turned ON/OFF by using the "remote control" function.

Between RC+ (pin10) and RC- (pin9)	Charger
SW open	ON
SW closed	OFF

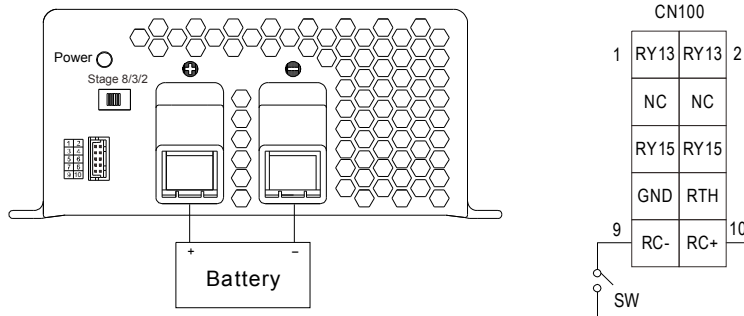

### 7.4 2, 3, or 8 stage charging mode selection

The charger features user selectable 2, 3, or 8 stage charging. The charging profile is selected by moving the slide switch on the back panel.

Switch	Charging mode
Slide right	2 stage charging
Middle	3 stage charging
Slide left	8 stage charging

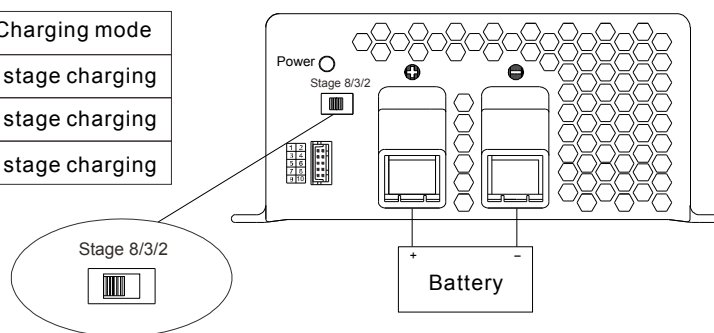

### 7.5 Reverse polarity protection

With built-in battery reverse polarity detection circuit. When the battery is connected in reverse at the output terminal of the charger, the output relay circuit will remain open.

### 7.6 Fan speed control

With built-in fan speed control circuit, the fan will automatically change speed depending on load condition.

### 7.7 Charger OK relay (RY15)

Charger	Between pin5 and pin6
Work normally	ON (short)
Failure or protection function activated	OFF (open)

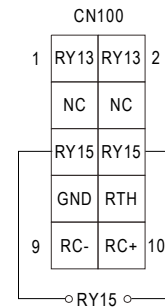

### 7.8 Output OK relay (RY13)

Battery	Between pin1 and pin2	Color of LED
Battery full	ON (short)	Green
Charging	OFF (open)	Orange

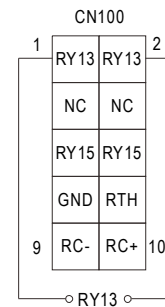

### 7.9 Temperature compensation

Temperature sensor which comes with the charger can be connected to the unit to allow temperature compensation of the charging voltage. **If the temperature sensor is not used, the charger can still work normally.**

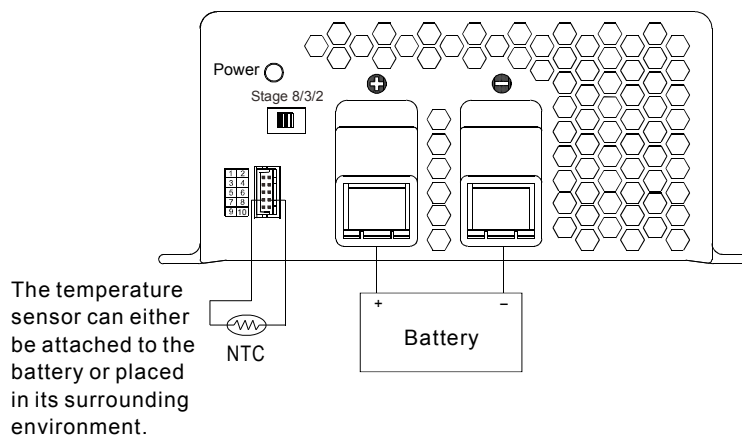

### 8. Wiring for battery

Select suitable wire gauge based on rated charging current. Refer to the following table for minimum wire gauge. We highly recommend using RED wire for + connection and BLACK wire for - connection:

AWG	CROSS SECTION(mm <sup>2</sup> )	Max. Current(A) UL1015(600V 105°C)
14	2.1	12
12	3.3	22
10	5.3	35
7	10	46
6	16	60
4	25	80

### 9. Suggested battery capacity

Model	Battery capacity
PB-600-12	135-400AH
PB-600-24	70-210AH
PB-600-48	35-105AH

Note: 1. Using battery capacity larger than the suggested value will not lead to damage of the battery. The main drawback is it may take longer to fully charge the battery.

2. If you're unsure about max allowable charging current of your battery, please refer to the battery's technical specification or consult its manufacturer.

### 10. Series and parallel connection of batteries

#### 1. Batteries in series

Voltage can be doubled when 2 batteries are connected in series. However, the capacity (Ah) will remain the same. For example, 2 x 12V 100Ah batteries connected in series = 24V 100Ah.

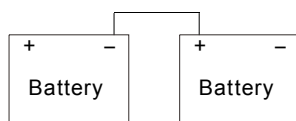

## 2. Batteries in parallel

When 2 batteries are connected in parallel, voltage remains the same and the capacity (Ah) doubles. For example, 2 x 12V 100Ah batteries connected in parallel = 12V 200Ah.

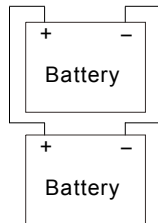

## 11. Recommended wire specification

Installation	Safety rating	Maximum length
Desktop, counter top, chassis box (mobile)	SP-2, SPE-2, SPT-2, SV, SVE, SVT	10ft (3 meter)
Grounded, fixed in place (not mobile)	S, SE, SO, SP-3, SPT-3, ST, STO, SJ, SJE, SJO, SJT, SJTO	Not specified

Note: Please install in accordance with the table above. Wire gauge should be no smaller than No. 18 AWG/3C. Socket type restricted to 15A, 125V (NEMA 5-15P) or 15A, 250V (NEMA 6-15P) with power cord length ranging from 1.8 meters to 10 meters.

## 12. Failure correction notes

Status	Possible reasons	Solutions
Unable to charge the battery	ON/OFF switch in the OFF position	Switch to the ON position
	Battery reverse polarity	Reconnect using the right polarity
	Battery with higher voltage is connected	Use battery with the correct voltage
	Input AC voltage is too low	Make sure input source is between 90~264VAC
LED indicator does not turn Green after a long charging period	Battery exceeded lifespan or damaged	Replace with a new battery
	Output cables are too thin	Replace with suitable wire gauge

**If you are not able to clear the failure condition, please contact Mean Well or any of our distributors for repair service.**

明緯企業股份有限公司

MEAN WELL ENTERPRISES CO., LTD.

248 新北市五股區五權三路 28 號

No.28, Wuquan 3rd Rd., Wugu Dist., New Taipei City 248, Taiwan

Tel:886-2-2299-6100 Fax:886-2-2299-6200

<http://www.meanwell.com> E-mail:[info@meanwell.com](mailto:info@meanwell.com)

*Your Reliable Power Partner*